

CLK, CLS, E-Klasse  
GLK-Klasse

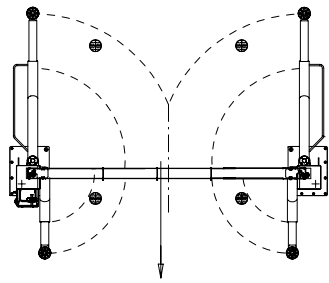

Smart  
Fortwo

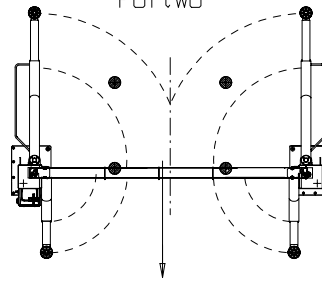

SLS

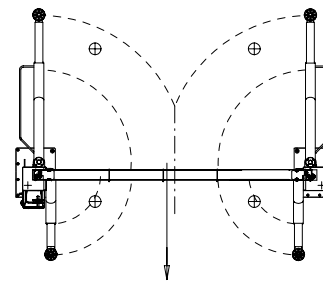

C-Klasse

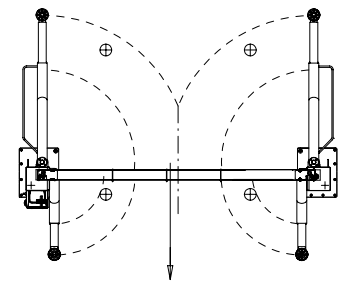

SLK

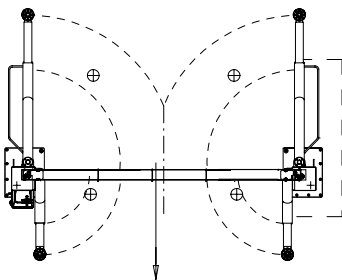

Vito/Viano  
mittlerer Radstand

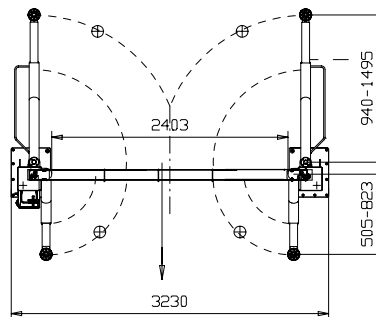

G-Klasse (GLK)

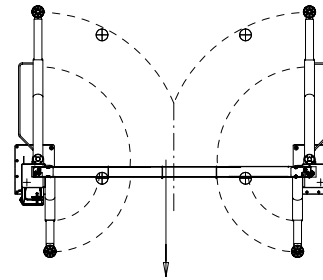

G-Klasse (W463)

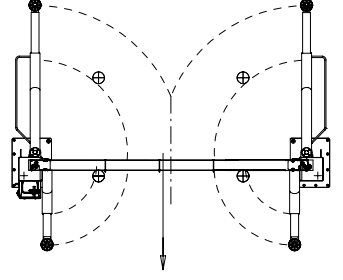

MB-Fahrzeuge  
geprüft 10.07.2014

HL 2.35 NT

Tragfähigkeit Capacity: 3500kg

10.07.14//M.G.

7482-2\_MB

**Nussbaum**

www.nussbaum-lifts.de